

AIRCRAFT DIMENSIONS

CHARACTERISTICS:

WING AREA - 300 SQ.FT

LEADING EDGE SWEEP 40 DEGREES

F-16

WING SPAN
32.8 FEET
W/MISSILES

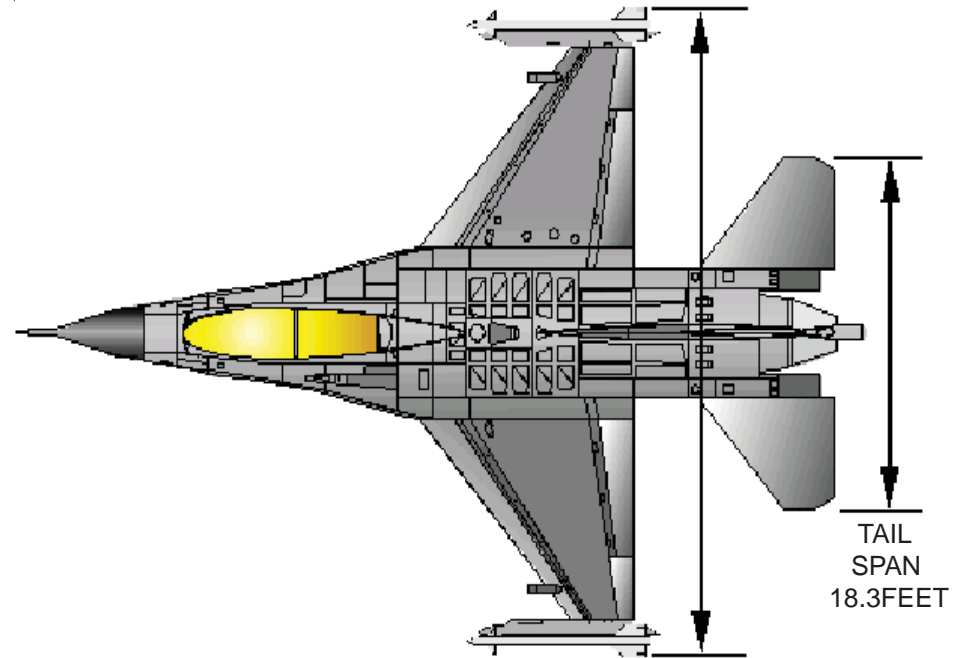

WING SPAN 31.0 FEET
(W/O MISSILES)

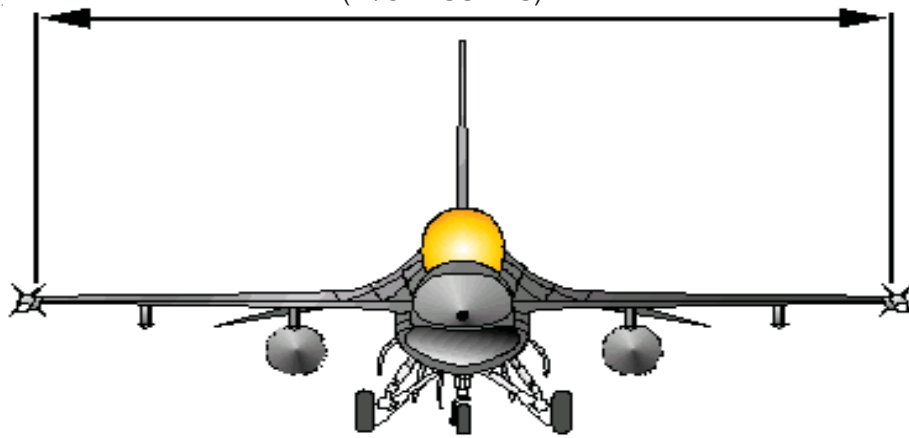

WHEEL BASE
7.8 FEET

HEIGHT
16.7 FEET

F-16A/C SINGLE-PLACE FIGHTER

LENGTH
49.5 FEET

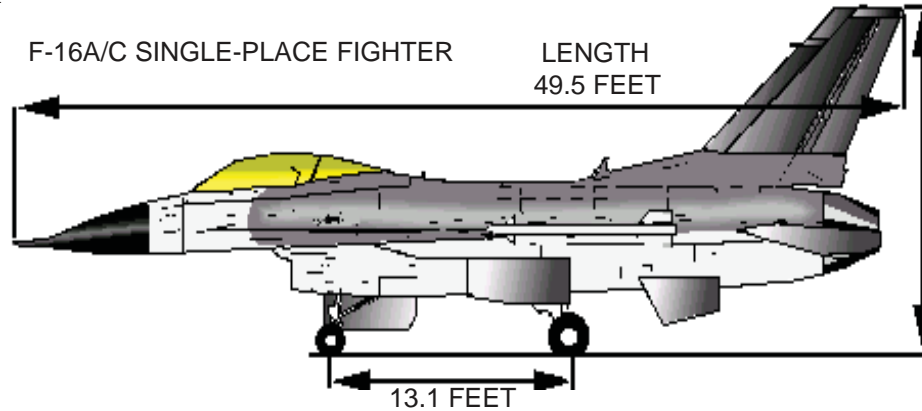

13.1 FEET

F-16B/D TWO-PLACE FIGHTER

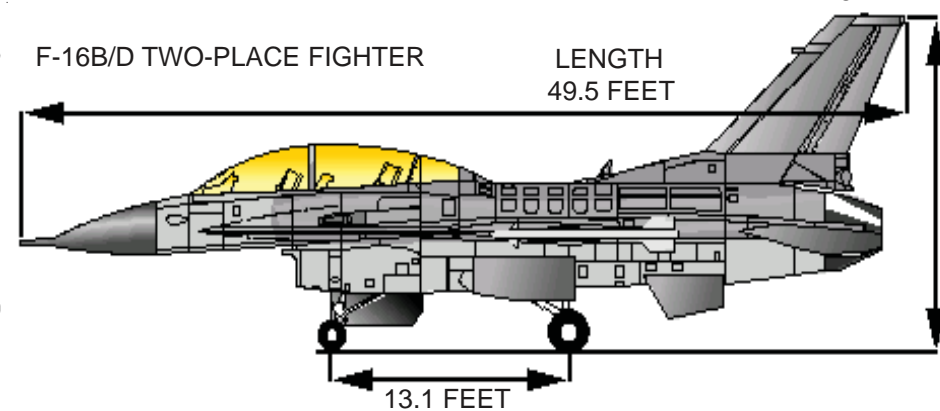

LENGTH
49.5 FEET



13.1 FEET

HEIGHT
16.7 FEET

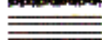

AIRCRAFT SKIN PENETRATION POINTS AND FIRE ACCESS LOCATIONS

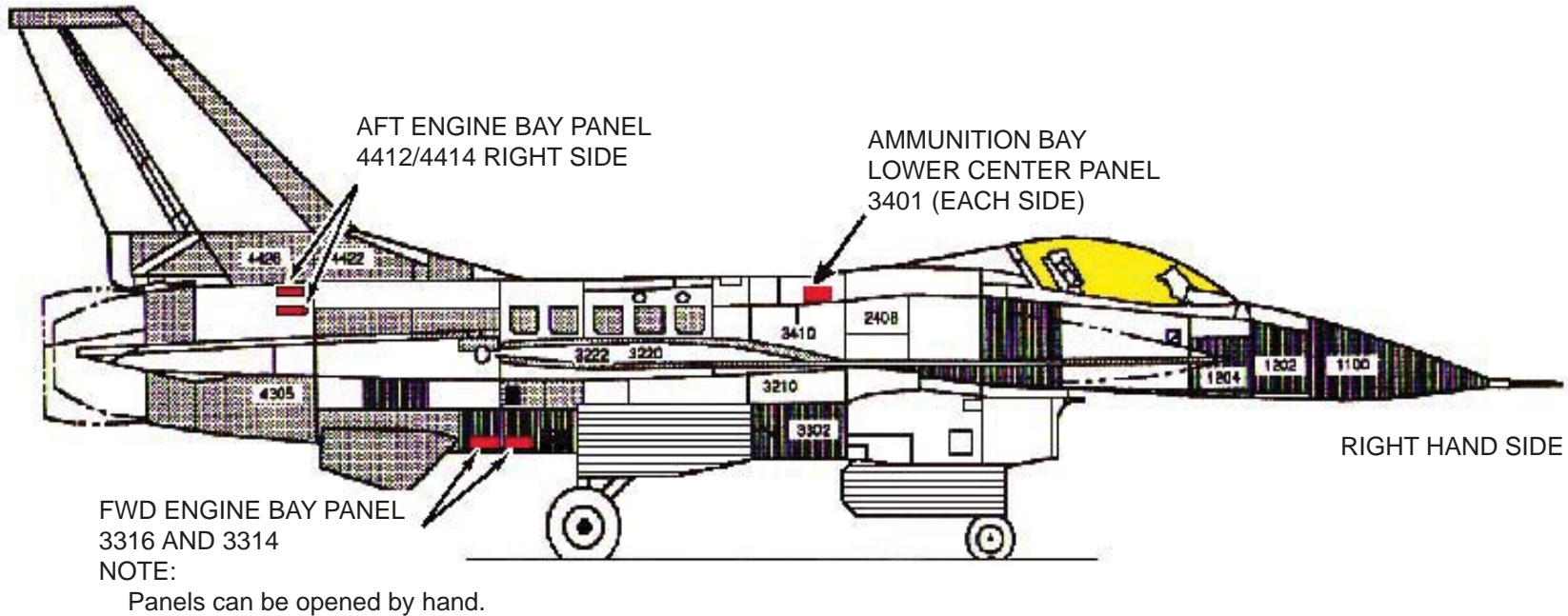
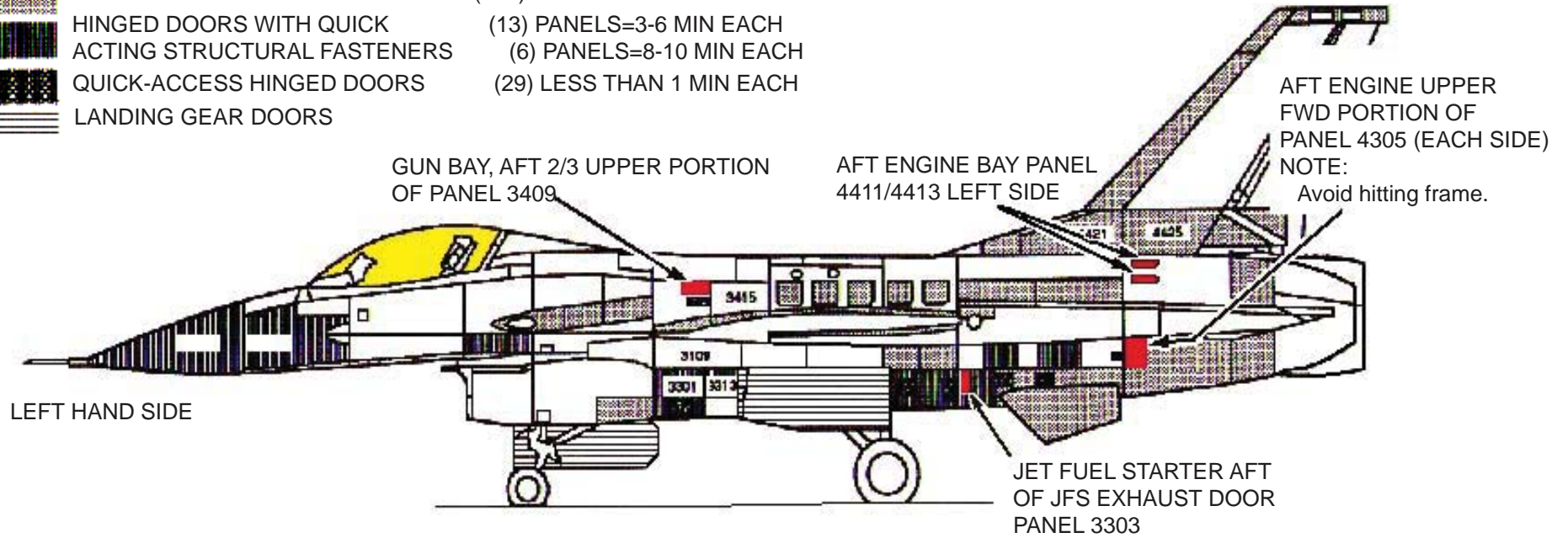
-  REMOVABLE STRUCTURAL COVERS (180) PANELS=6-62 MIN EACH
-  HINGED DOORS WITH QUICK ACTING STRUCTURAL FASTENERS (13) PANELS=3-6 MIN EACH
-  QUICK-ACCESS HINGED DOORS (29) LESS THAN 1 MIN EACH
-  LANDING GEAR DOORS



AIRCRAFT HAZARDS AND ACCESS PANELS

F-16

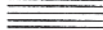
-  REMOVABLE STRUCTURAL COVERS (180) PANELS=6-62 MIN EACH
-  HINGED DOORS WITH QUICK ACTING STRUCTURAL FASTENERS (13) PANELS=3-6 MIN EACH
-  QUICK-ACCESS HINGED DOORS (6) PANELS=8-10 MIN EACH
-  LANDING GEAR DOORS (29) LESS THAN 1 MIN EACH

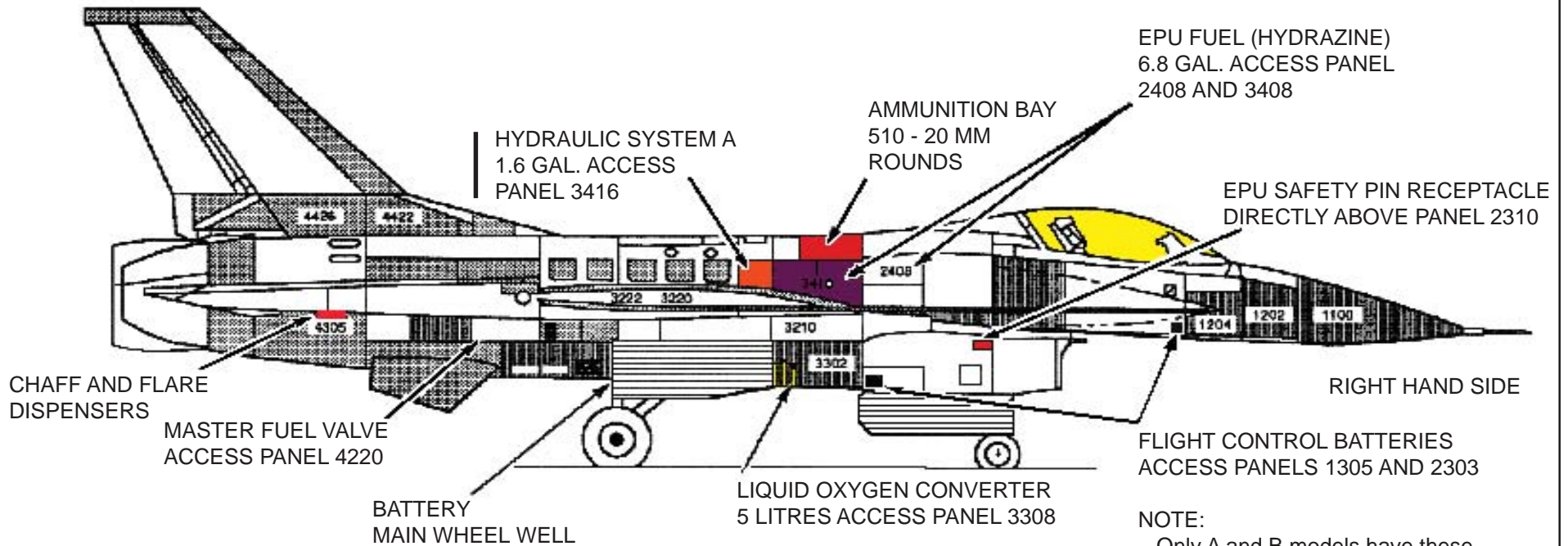
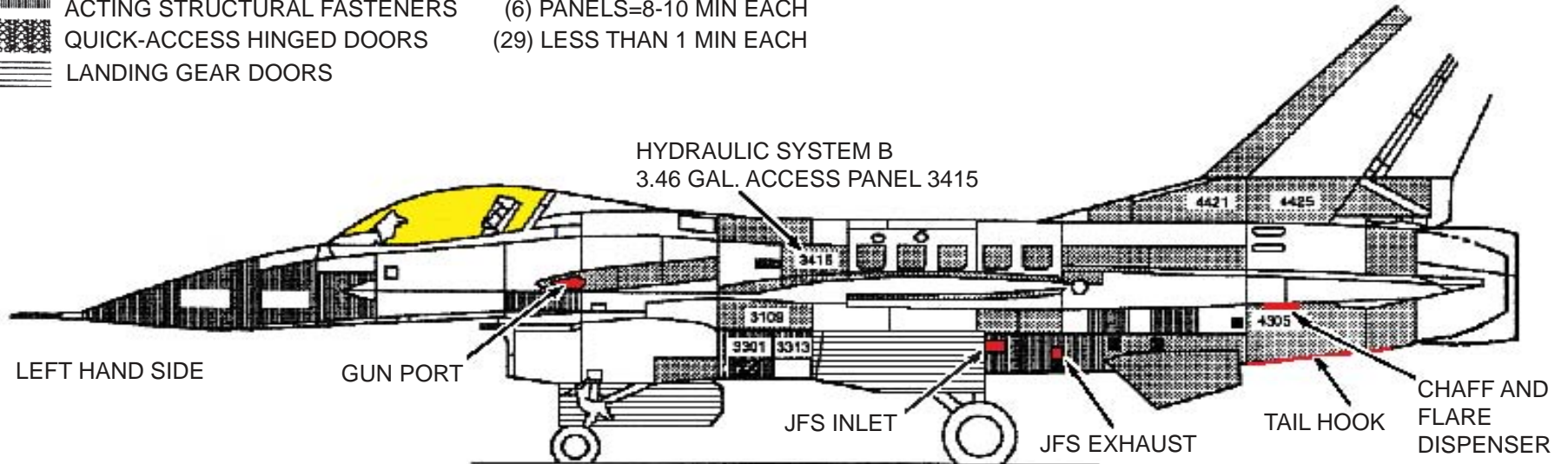

NOTE:
Only A and B models have these flight control batteries.

EPU FUEL-H-70 HYDRAZINE HAZARD

F-16

WARNING

AIRCRAFT CRASH OR EMERGENCY LANDING MAY RESULT IN HYDRAZINE SPILL OR VAPORS, RESCUE PERSONNEL WHO MAY BE EXPOSED SHALL WEAR SELF-CONTAINED BREATHING APPARATUS AND PROTECTIVE GARMENTS - FACE MASK AND PLASTIC OR RUBBER GLOVES AS A MINIMUM. SPILLED HYDRAZINE SHOULD BE DILUTED WITH EQUAL AMOUNTS OF WATER SPRAY TO RENDER NONFLAMMABLE.

CAUTION

IF EPU IS OPERATING IN THE HYDRAZINE MODE, SELF-CONTAINED BREATHING APPARATUS SHOULD BE WORN BY RESCUE PERSONNEL IN THE IMMEDIATE VICINITY OF AIRCRAFT AND DURING EMERGENCY CANOPY ENTRANCE. THE AMMONIA CONSTITUENT OF EPU EXHAUST MAY CAUSE IRRITATION OF EYES, NOSE AND THROAT.

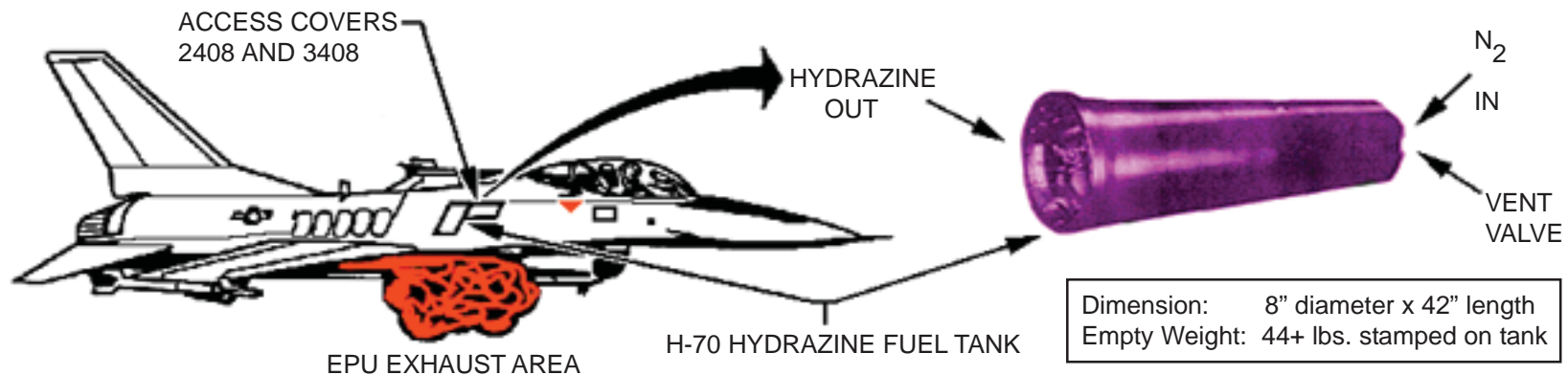

GENERAL INFORMATION:

- F-16 Emergency Power Unit (EPU) Uses 70% Hydrazine and 30% Water Blend (H-70) as Fuel.
- Exhaust Gases from EPU Turbine are 40% Ammonia, 17% Nitrogen, 15% Hydrogen and 28% Water.
- EPU Operation Results in Noise Similar to a high pitched whine.
- Fire Hazards of Hydrazine are Similar to JP-4.
- Odor (Ammonia) Threshold is 2 to 3 ppm.
- OSHA Hydrazine Exposure Limit is 1.0 ppm Average Over an 8 Hour Period.
- ACGIH Hydrazine Exposure Limit is 0.01 ppm Average Over an 8 Hour Period; Excursion Up to 0.3 ppm are Permitted, Provided 0.01 ppm Average for 8 Hours is Not Exceeded.
- For additional information, refer to TO 1F-16A/C-2-49GS-00-1, Section IV, H-70 Fuel Spill Management and Neutralization.

AIRFRAME MATERIALS

F-16

LEGEND

- ALUMINUM - 78.4%
- STEEL - 11.0%
- TITANIUM - 0.8%
- COMPOSITE - 3.0%
- FIBERGLASS - 6.8%
- M300 STEEL - 6.8%
- BONDED FULL DEPTH CORE - 6.8%

NOTE:

Engine heat shield and lower wing attach fittings are Titanium. The engine nozzle is Titanium for GE engines and the F100-PW-200/220 and composite for the F100-PW-229.

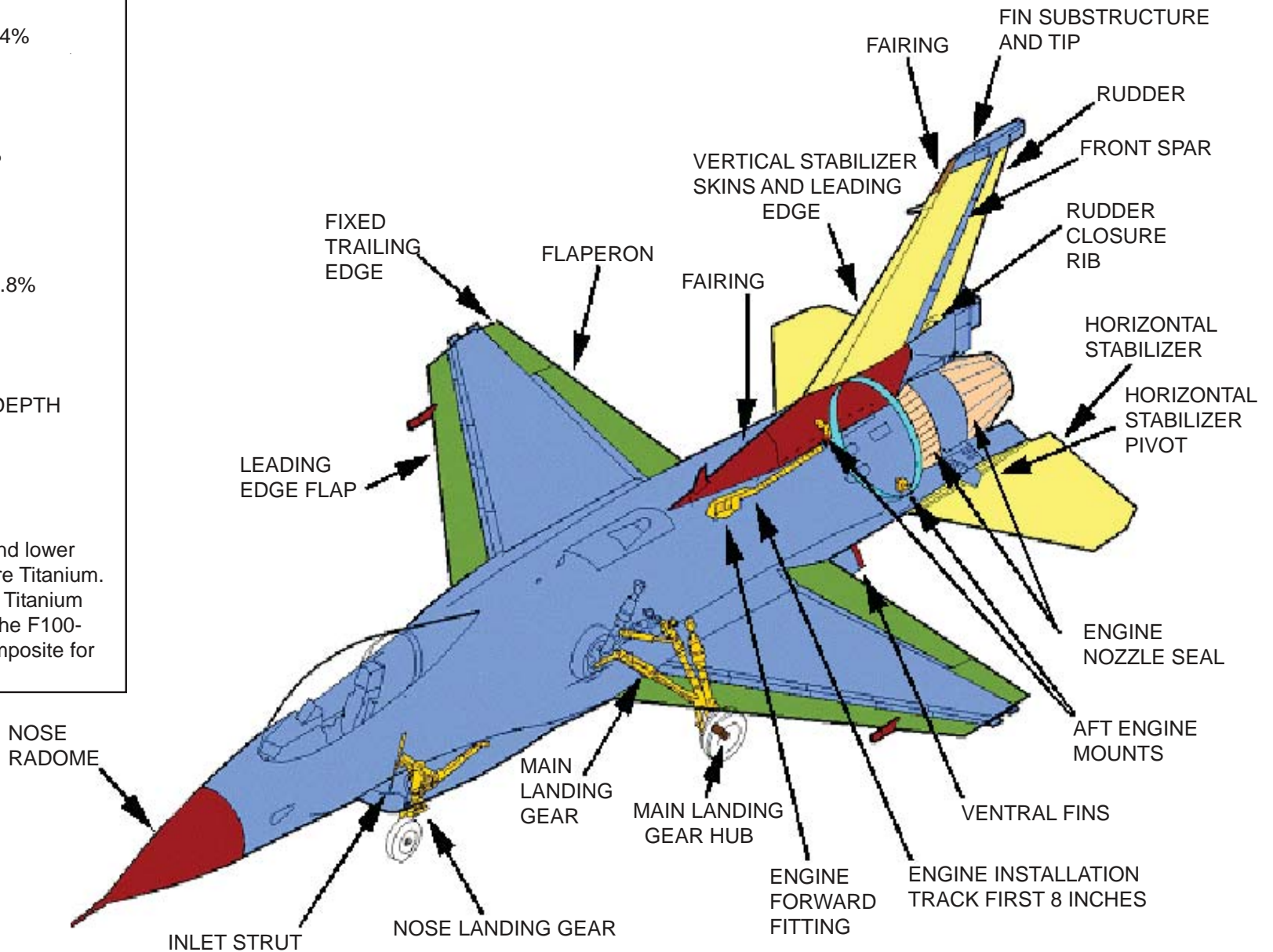

AIRFRAME MATERIALS-Continued

F-16

COMPOSITE WEIGHTS

NOTE:

Use the legend on page F-16.7 for composites color coding.

Various type versions of the F-16 use 171-222 pounds of composite materials for the skins of the horizontal tails, vertical fin and rudder, as well as certain structure inside the vertical fin.

F-16A/B: Small Tail 171 lbs

F-16A/B: Big Tail 222.6 lbs

F-16C/D: 222.3 lbs

F-16 C/D COMPOSITE MATERIALS LOCATION AND DESCRIPTION

Composite materials are in the ventral fins, vertical and horizontal stabilizers and radome. Because of redesigns, expect to find other miscellaneous aircraft parts made out of composite materials. The C/D ventral fin is a bonded assembly that incorporates a fiberglass epoxy sandwich laminate in the aft region. The core is an organic material. The horizontal stabilizer consists of two basic structures, the main box and the leading edge assembly. The main box is skinned with a carbon fiber epoxy laminate. The laminate's surface layer is a glass woven fabric. Underneath the fabric layer are layers of unidirectional carbon fiber/epoxy tape. Each tape layer has a specific fiber orientation. This will be obvious when looking at an impact-damaged piece. There may be woven fabrics dispersed among the tape layers. The laminate is bonded to a corrugated aluminum surface. There is a layer of fiberglass between the aluminum surface and the carbon fiber layer.

The leading edge is a sandwiched composite. The skin is a carbon fiber epoxy laminate bonded to an aluminum honeycomb core. A carbon fiber epoxy channel section is used as an aft closure beam bonded to the sandwiched laminate. A fiberglass wedge is used as a leading edge closure capped with stainless steel.

The radome is a glass/epoxy filament wound composite with a surface layer of a woven glass fabric. The F-16 radome fiber directions are longitudinal and circumferential. The fin box of the vertical tail is skinned with carbon fiber epoxy laminate. The lower fin leading edge is a carbon fiber/epoxy sandwich laminate. The rudder contains a carbon fiber / epoxy sandwich laminate. The core is an aluminum honeycomb material. The vertical tail dorsal fairing skin is fiberglass.

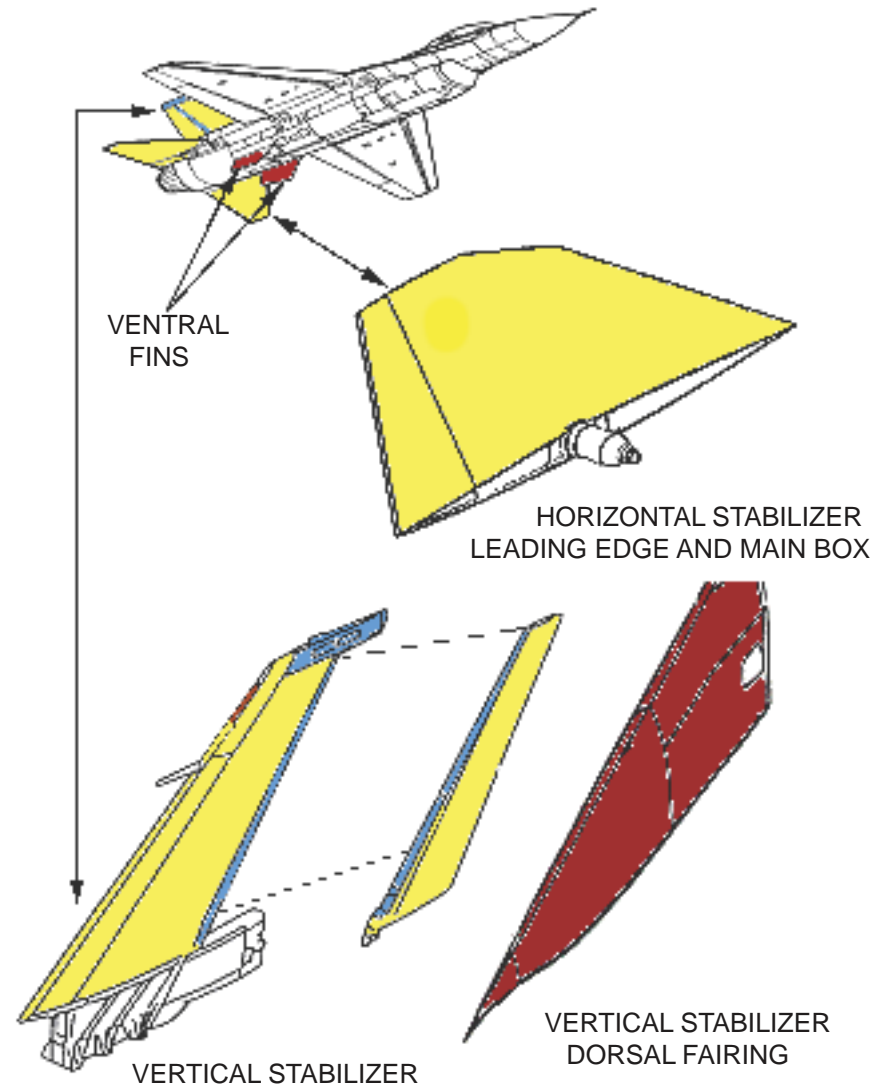

AIRCRAFT DANGER AREAS

RADIATION AND ANTENNAS

NOTE:

- Distance from radar disc to forward tip of radome = 5 feet.

F-16

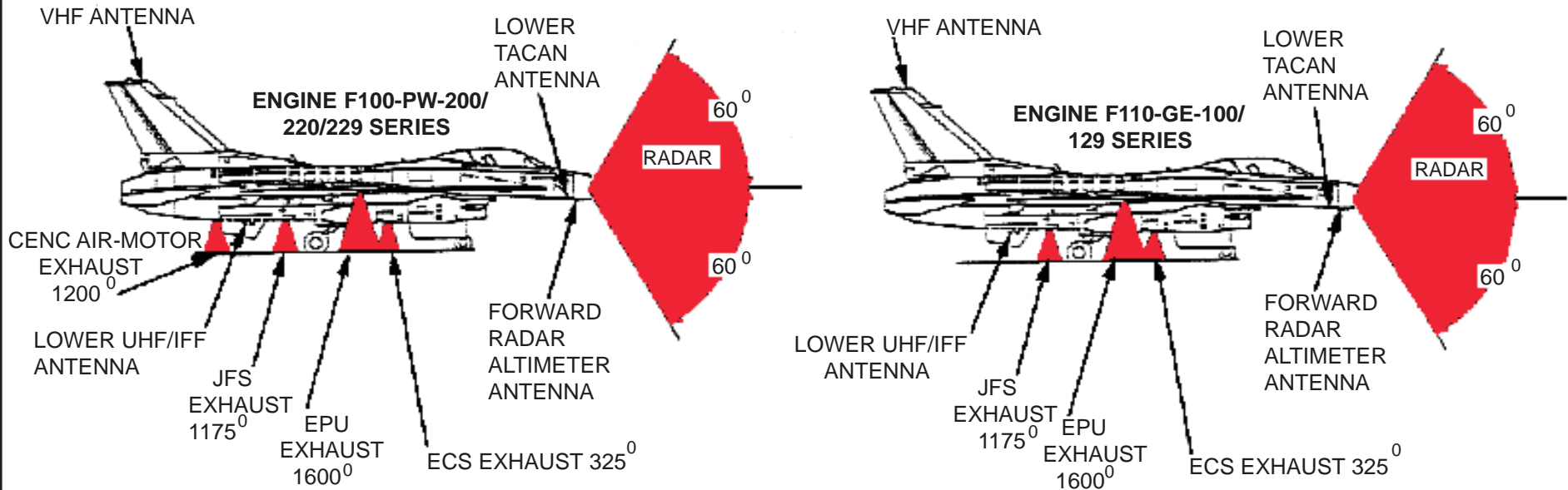

COMMON TO BOTH ENGINES

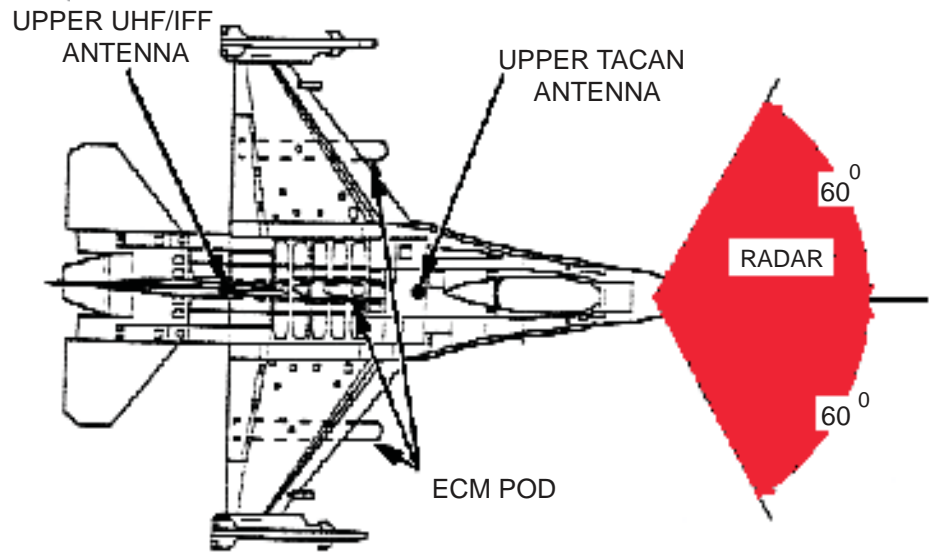

OPERATING TRANSMITTERS	MINIMUM SAFE DISTANCE FROM ANTENNAS IN FEET		
	VOLATILE FLUIDS	PERSONNEL	EED
UPPER AND LOWER UHF/IFF	--	2	--
UPPER AND LOWER TACAN	--	1	--
VHF	--	1	--
RADAR ALTIMETER	--	1	--
FIRE CONTROL RADAR	30	120	120
AN/ALQ-119	--	6	6
AN/ALQ-131	--	15	15
AN/ALQ-176	--	6	6
AN/ALQ-184	--	31	6
AN/ALQ-188	--	6	6
QRC-80-01	--	6	6

AIRCRAFT DANGER AREAS-Continued

ENGINE THRUSTS FOR F110-GE-100/129

F-16

CAUTION

The safe distance to maintain around engine intakes is 25 feet regardless of thrust.

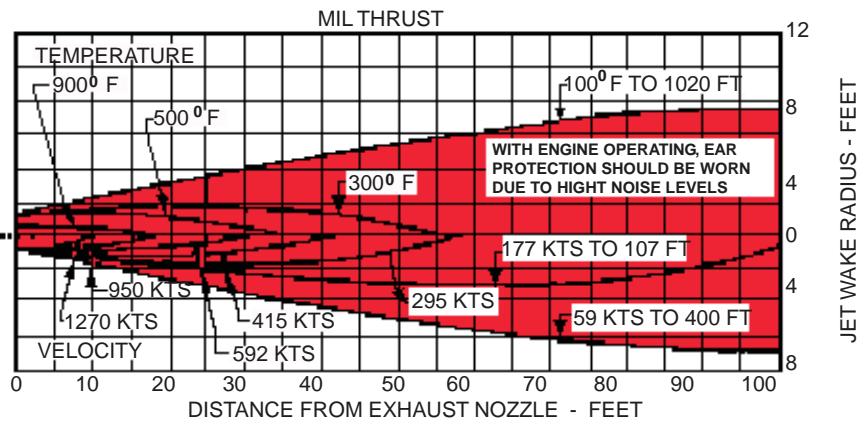
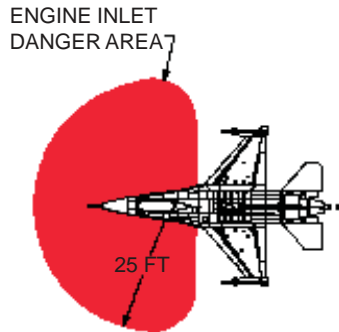
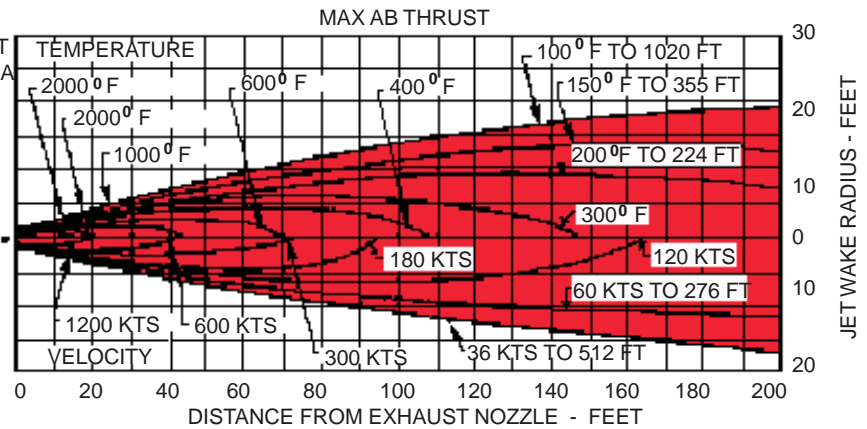
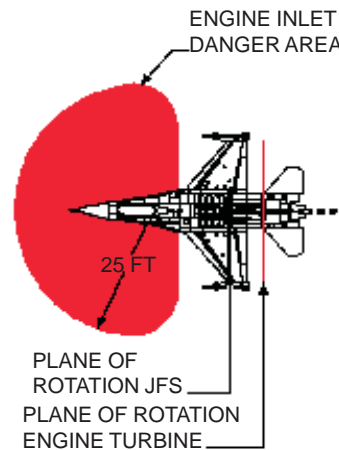

TIRES AND HOT BRAKES
Avoid inflated MLG tire side area within 300 feet for 45-60 minutes after aircraft has stopped. If required, approach from the front or rear only.

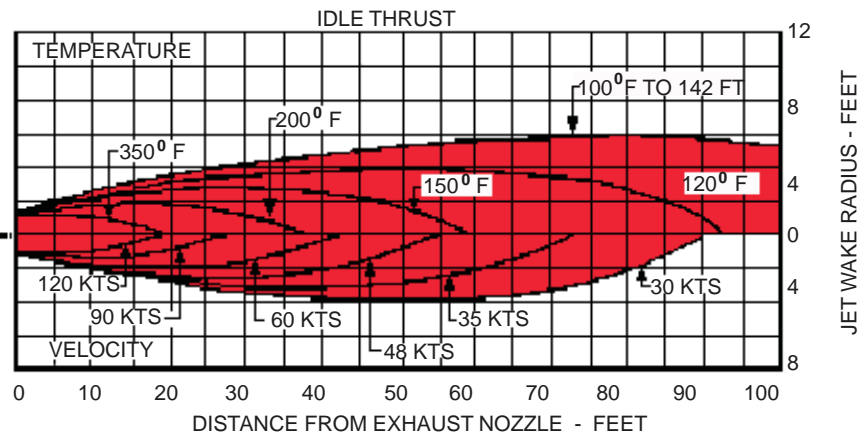
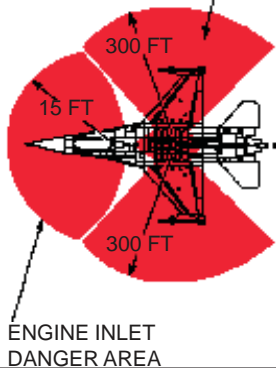

SPECIAL TOOL

LOCAL MANUFACTURED TOOL

NOTE:

This tool can be locally manufactured with 1/4" keyway stock for the 1/4" plug removal on the left side fuselage. The 1/4" keystack will prevent wearing out the plug head and accelerate the rescue process. See page F-16.10 steps 2a and 3a for application. Attach this tool to a socket wrench or speed handle. A substitute tool for the socket wrench or speed handle can be a cordless drill.

WARNING

DO NOT USE A POWERED DRILL TO OPEN THE CANOPY! The canopy mechanisms are not engineered for rapid opening and a malfunction can occur resulting in a possible falling canopy and failed rescue!

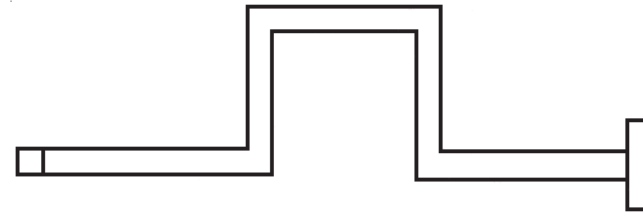

TYPICAL 1/4" DRIVE SPEED HANDLE FOR SPECIAL TOOL

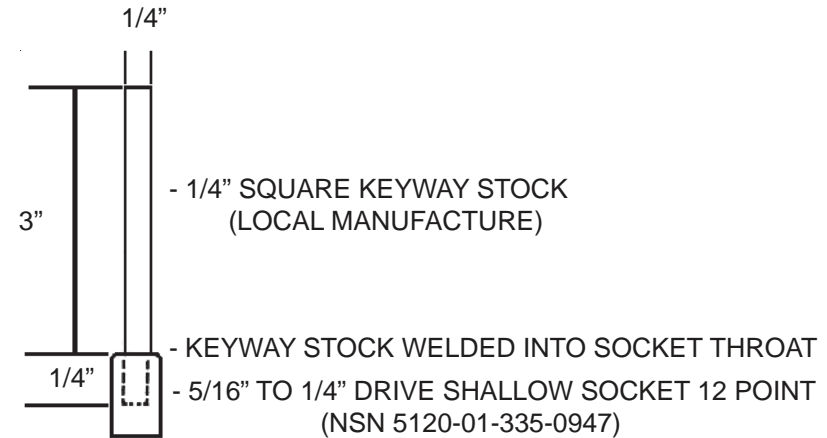

SPECIAL TOOLS/EQUIPMENT

Power Rescue Saw w/ Carbide Tipped Toothed Cutting Blade
Speed Handle -1/4 In. Drive Socket Drive
1/4 In. Drive Apex Holder w/ 9/64 Inch Apex
2 each Safety/Gun Pins P/N NAS1333C3C151D or Equivalent
0.149 to 0.125 Diameter Drill Rod at least 8 In.
Cordless Drill Fire Drill II Wire Cutters/Dikes
Portable Engine Shutdown Box

AIRCRAFT ENTRY

CAUTION

Entry procedures vary if engine is running. Pilot maybe active or incapacitated and condition of aircraft is uncertain. Refer to either normal or emergency procedures.

WARNING

DO NOT PIN NOSE GEAR OR THE EPU UNTIL ENGINE IS SHUTDOWN! PERSONNEL IN THIS AREA ARE IN THE ENGINE INTAKE DANGER ZONE AND THE SAFETY PINS AND STREAMERS ARE CONSIDERED F.O.D. HAZARDS.

WARNING

FOR AN ACTIVATED EPU

The EPU is no longer required to be safed after EPU activation and/or until engine is shutdown. The EPU contains 6.8 gallons of hydrazine fuel. Personnel will not approach engine intake closer than five feet from either side or rear and maintain a safe distance of 25 feet from front intake when engine is running. Safety pinning an activated EPU unnecessarily places firefighters/rescue personnel in imminent danger working near the engine intake. Disregarding this **WARNING** could result in **injury or death** to rescue personnel and possible engine F.O.D. with the EPU safety pin assembly. (See Danger Zones on pages 11 thru 13.)

TOTAL FUEL
2,109 US GALS.

F-16

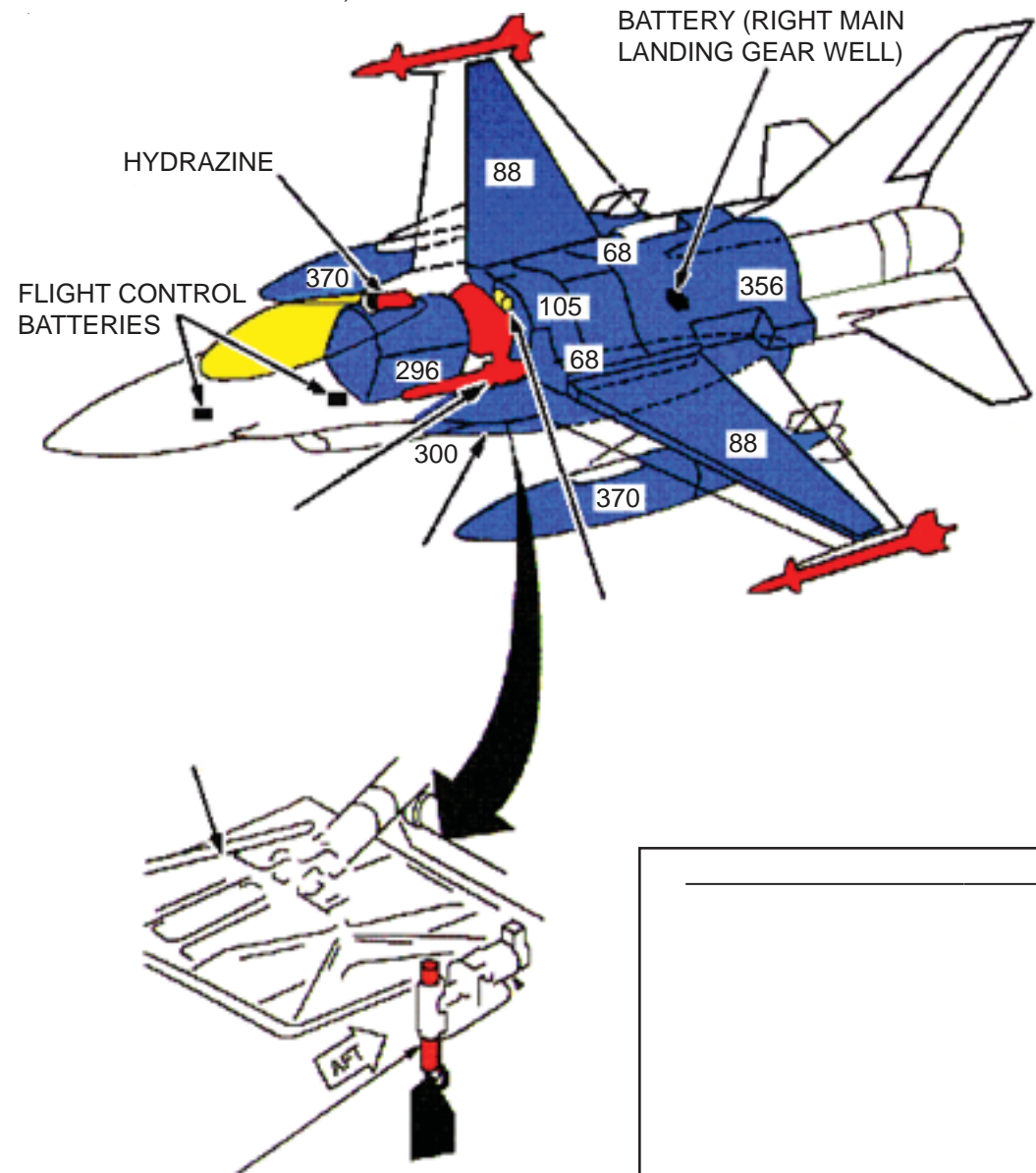

AIRCRAFT ENTRY-Continued

F-16

2. NORMAL ENTRY

NOTE:

If canopy is not locked from the inside, move the external canopy switch, located at left wing strake at door 2105, to the UP position to open canopy.

- Use a 1/4 inch dr. socket wrench or speed handle to remove unlock access plug, located left side of fuselage. Use cordless drill to remove plug if stripped.
- Insert at least a 0.149 to 0.125 inch diameter drill rod into crank insert opening and push inboard to unlock canopy.
- Access door 2105, depress thumb catch and move the external canopy switch to the UP position to open canopy.

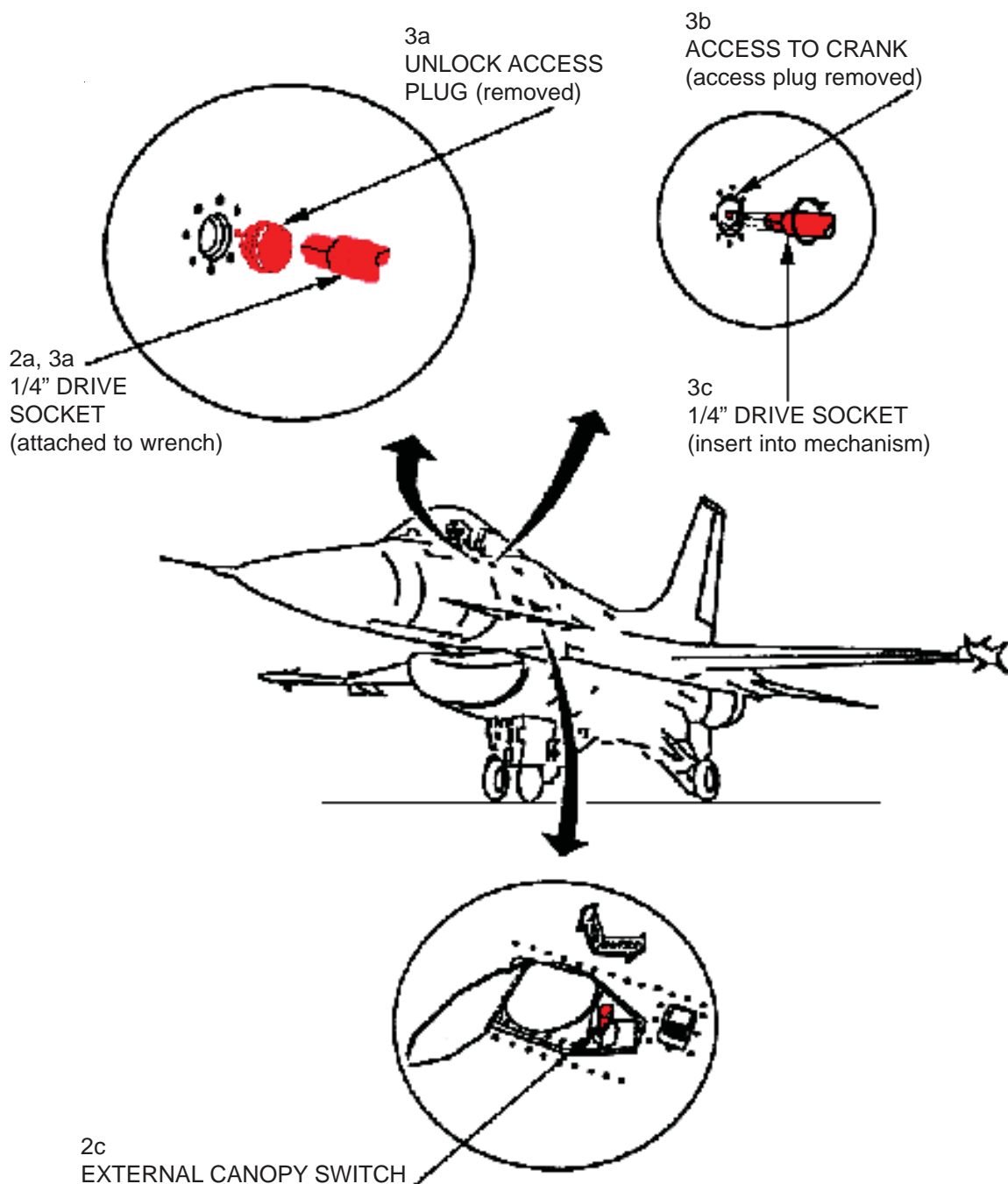

3. MANUAL ENTRY

- Use a 1/4 inch dr. socket wrench or speed handle to remove unlock access plug, located left side of fuselage. Use cordless drill to remove plug if stripped.
- Insert at least a 1/8 inch diameter drill rod into opening and push inboard to unlock canopy.
- Insure that canopy unlock handle is raised to unlock position. Insert 1/4 inch dr. socket wrench or speed handle into crank insert opening mechanism located left side of fuselage aft of unlock access plug.
- Rotate canopy opening mechanism clockwise 52 revolutions to fully open a single seat F-16A/C canopy or 87 revolutions on a two seat F-16B/D.

AIRCRAFT ENTRY-Continued

F-16

4. EMERGENCY ENTRY

WARNING

- If the canopy is restrained by debris or jammed by crash damage, do not jettison the canopy. Attempted jettison may result in a portion of the canopy rocket exhaust entering the cockpit. This exhaust may expose the crewmembers to a toxic gas, heat, and blast hazard.
 - Flames, heat, and blast from the canopy jettison rocket exhaust nozzles will extend to the pavement and could ignite flammable fluids and vapors.
- a. Open canopy emergency release door, located on each side of fuselage below canopy. Only one canopy release door needs to be opened to jettison the canopy. Only one thumb latch per door is installed and only one thumb latch needs to be pushed.
 - b. Extend jettison handle to full length (approximately 6 feet) and pull to jettison canopy.

5. CUT-IN

NOTE:

Due to the strength of the canopy transparency, all sides of the canopy must be cut to reach the crewmember(s).

WARNING

Extreme caution must be taken during the cutting operation to avoid hitting the canopy jettison rockets and other ballistic components mounted in or near the canopy frame.

- a. Cut through the canopy transparency using a power rescue saw with a carbide tipped, toothed cutting blade. On a F-16B/D, the aft seat transparency material is thinner and easier to cut.

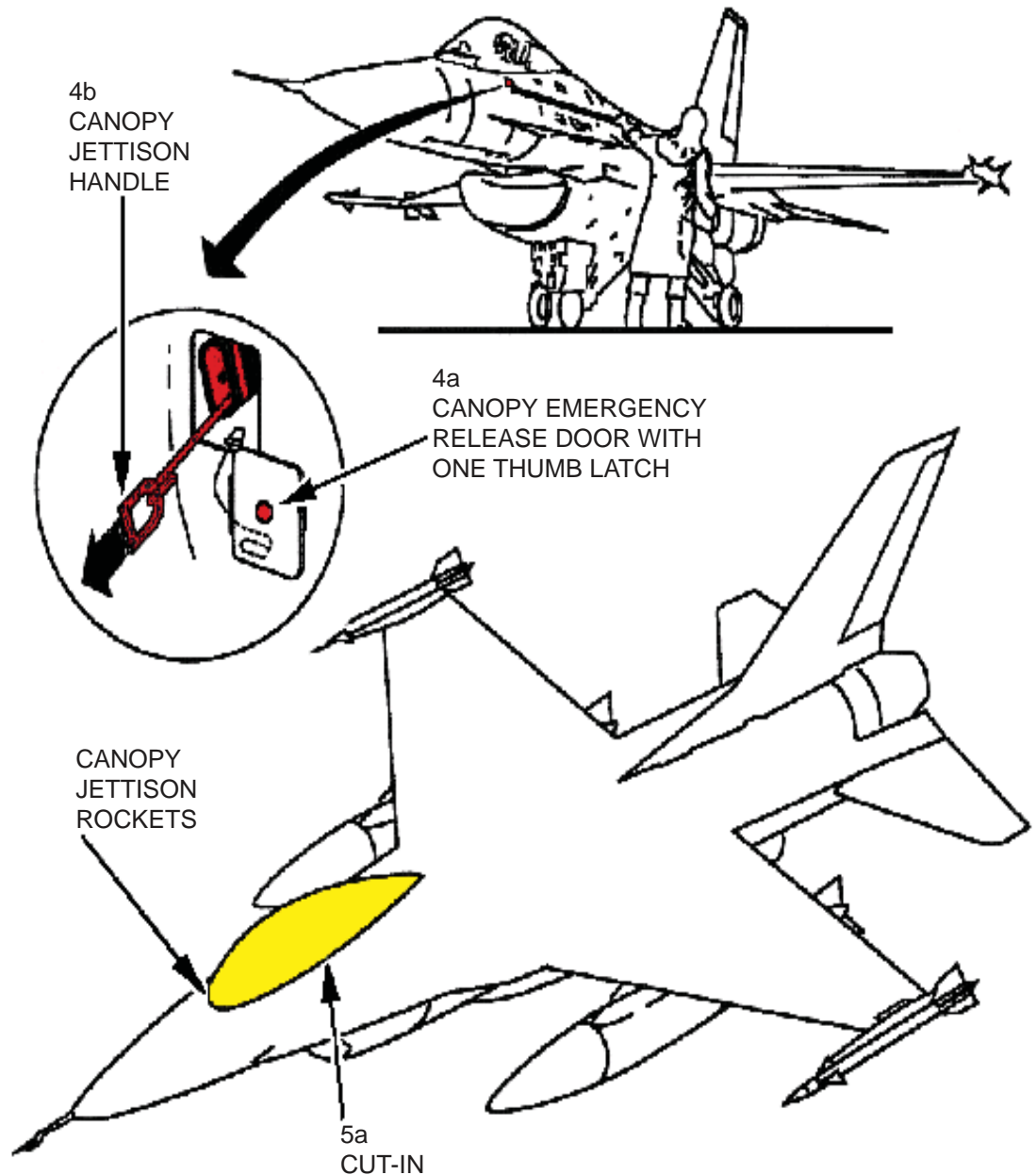

EMERGENCY ENGINE SHUTDOWN #1

F-16

NOTE:

Use the appropriate shutdown procedures #1 - 4 to fit the emergency.

1. INCAPACITATED PILOT OR UNMANNED COCKPIT OR EJECTED SEAT(S) WITH UNIMPEDED ENTRY TO COCKPIT

- a. Enter cockpit and move throttle, located on left console (fwd cockpit only on F-16 two seat models) while tilting throttle grip upward/outboard and squeezing throttle cutoff release trigger to proceed from IDLE to OFF position. (The throttle of F-16 two seat models cannot be positioned to OFF in rear cockpit.)

NOTE:

F-16A/C also has a fuel master switch, located on the fuel control panel just aft of the throttle and two seat models have a fuel master switch in rear cockpit.

- b. If the engine fails to shutdown, place fuel master switch, located on fuel control panel directly aft of the throttle to OFF position.
- c. Place the EPU switch, forward of the fuel control panel, to OFF position.

NOTE:

Some F-16s may have the MFSOV safety wired open. Safety wire on the MFSOV must be cut and removed to allow the MFSOV to close electrically when the fuel master switch is placed in the OFF position.

- d. Place main power/battery switch, located forward of fuel master switch, to OFF position.
- e. Disconnect aircraft battery, located in the right main wheel well, if accessible. See page F-16.15.

NOTE:

If the EPU fires during the emergency ground rescue sequence, reduced electric and hydraulic demands will permit hydrazine quantity to support approximately 15 minutes of EPU operation if EPU safety pin is not installed.

- f. After engine shutdown, install the EPU safety pin (pin installation terminates/prevents EPU operation). (See page F-16.20.)

NOTE:

Without weight on wheels, battery power can only be removed by disconnecting the single electrical connection from the battery.

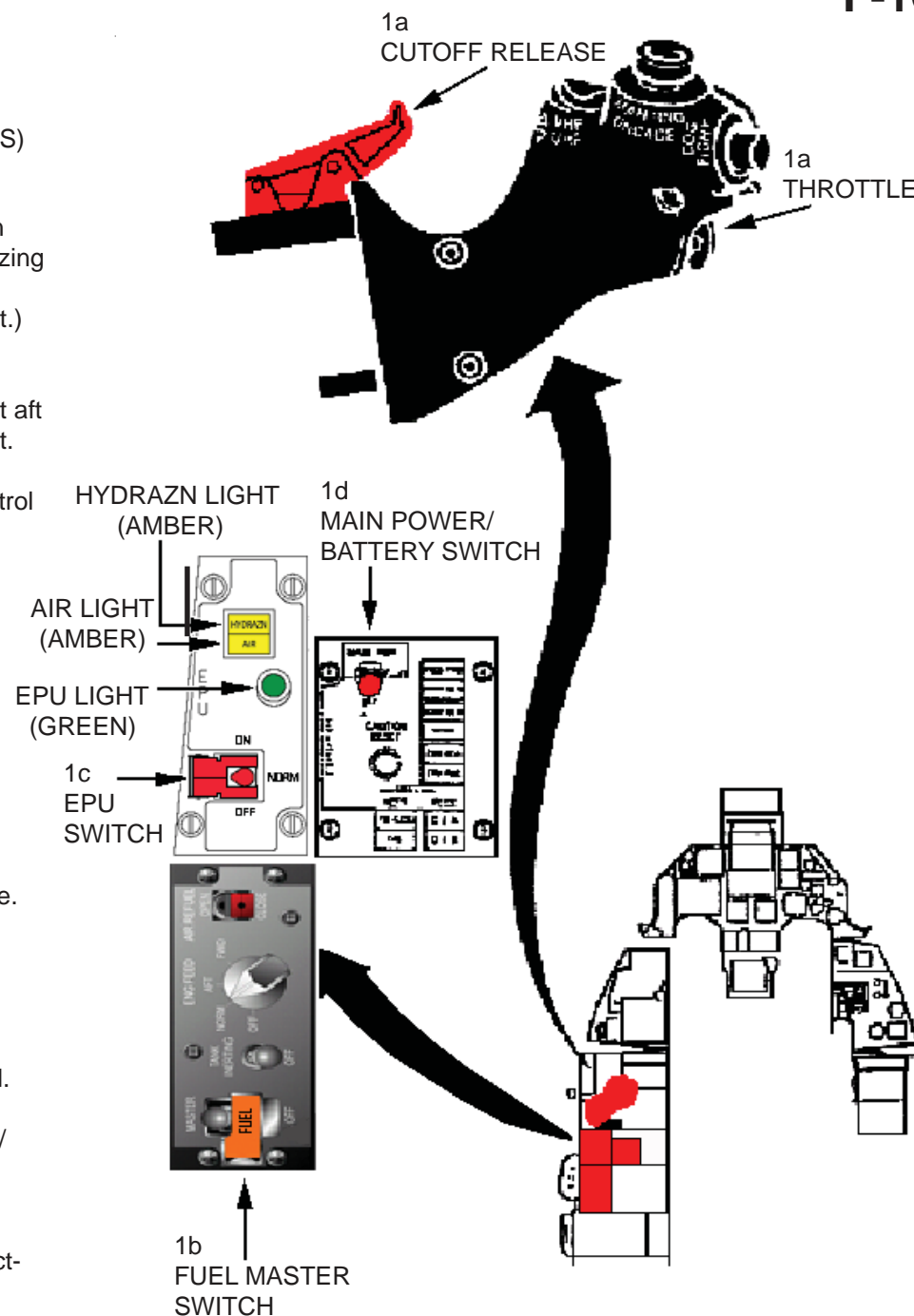

EMERGENCY ENGINE SHUTDOWN #2

F-16

2. INCAPACITATED PILOT OR UNMANNED COCKPIT OR EJECTED SEAT(S) WITH IMPEDED ENTRY TO COCKPIT

WARNING

When the EPU is operating, hydraulic and electric power will be available to move flight control surfaces. Review existing danger areas on pages F-16.10 - F-16.13 to prevent injury or death to personnel working under extreme emergency conditions.

- a. Be aware the EPU may activate during engine shutdown. See page F-16.20.
- b. Gain access to the MFSOV, located under panel 4220 at the right wing root below the flap hinge.

NOTE:

If panel 4220 is not accessible, perform applicable Aircraft Entry or Emergency Entry procedures on pages F-16.16 and F-16.17 and then proceed to next page.

- c. Depress the thumb latch on panel 4220 and lower panel for access to MFSOV.
- d. Disconnect the cannon plug or manually cut (with insulated dikes) the harness to MFSOV to remove electrical power.

NOTE:

Failure to remove electrical power will not allow shutdown using the MFSOV lever.

- e. Check for and, if installed, cut the safety wire located on MFSOV lever.

WARNING

Beware of possible movement of flight control surfaces and/or aircraft when MFSOV lever is moved to the CLOSE position. At high RPM, holding lever may prove difficult. The degree of closure may be sufficient to reduce RPMs allowing cockpit access to the fuel master switch.

- f. Push inboard, maintain forward pressure on MFSOV lever and hold. If lever can be held in CLOSE position, shutdown should occur in less than 1 minute. Shutdown time depends on engine type and power setting.

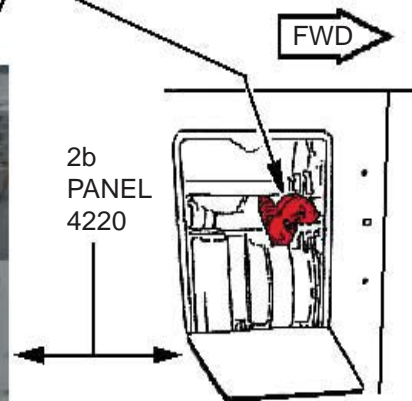
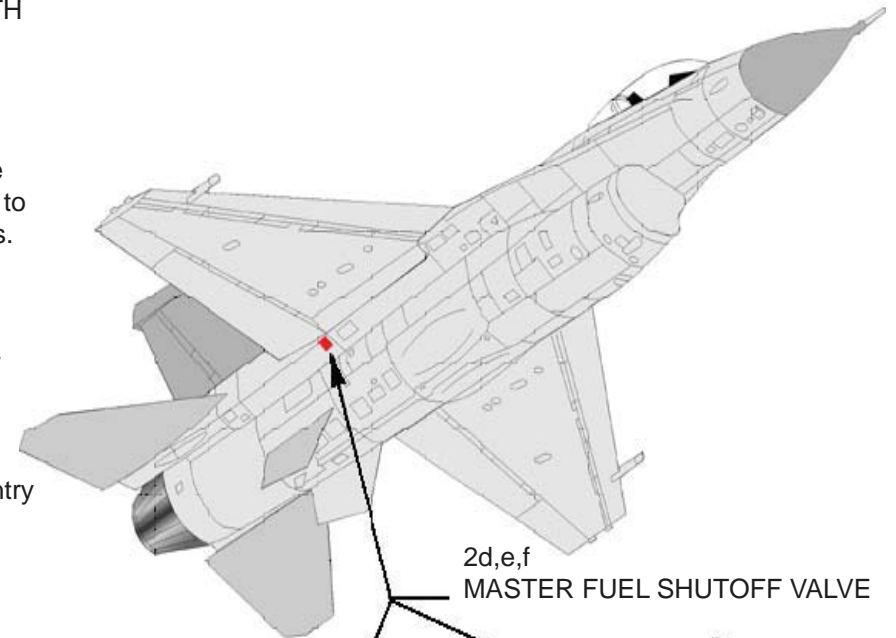

SIDE VIEW

VIEW LOOKING UP

EMERGENCY ENGINE SHUTDOWN #3

F-16

3. ACTIVATED EPU - PILOT ACTIVE

CAUTION

Unless weight is on wheels, the EPU will start up when the engine is shutdown. Chock left main landing gear, beware of hazards and moving flight control surfaces around running aircraft. **Manually operating the MFSOV will be understood as a last resort.**

NOTE:

Pilot action is required for the following steps: a - c only. Remaining steps are performed by rescue crew.

- a. Confirm EPU switch is in the OFF position.
- b. Confirm the throttle is in the OFF position.
- c. Confirm main power/battery switch is in OFF position.
- d. After engine has stopped, install EPU safety pin in EPU pin receptacle, located on lower right inlet skin just above access panel 2310, approximately 3.5 feet aft of engine inlet lip engaging the EPU ground safety switch. (If the EPU fires during the emergency ground rescue sequence, reduced electric and hydraulic demands will permit hydrazine quantity to support approximately 15 minutes of EPU operation if EPU safety pin is not installed.)

NOTE:

If conditions make installation of the EPU safety pin impossible or impractical, disconnecting the battery in right main wheel well will prevent startup of EPU.

- e. If the engine fails to shutdown, gain access to the MFSOV (Main Fuel Shut Off Valve), located under panel 4220 at the right wing root below the flap hinge.
- f. Depress the thumb releases on panel 4220 and lower panel for access to MFSOV.

NOTE:

Failure to remove electrical power will not allow shutdown using the MFSOV lever.

- g. Disconnect the cannon plug or manually cut (with insulated dikes) the harness to MFSOV to remove electrical power.
- h. Check for and if installed, cut safety wire located on MFSOV lever.

NOTE:

At high RPM, holding MFSOV lever may prove difficult. The degree of closure may be sufficient to reduce RPMs allowing cockpit access to the fuel master switch.

- i. Push inboard and maintain forward pressure on MFSOV lever. If lever can be held in close position, shutdown should occur in less than 1 minute.

NOTE:

Without weight-on wheels, battery power can only be removed by disconnecting the electrical connections from the battery.

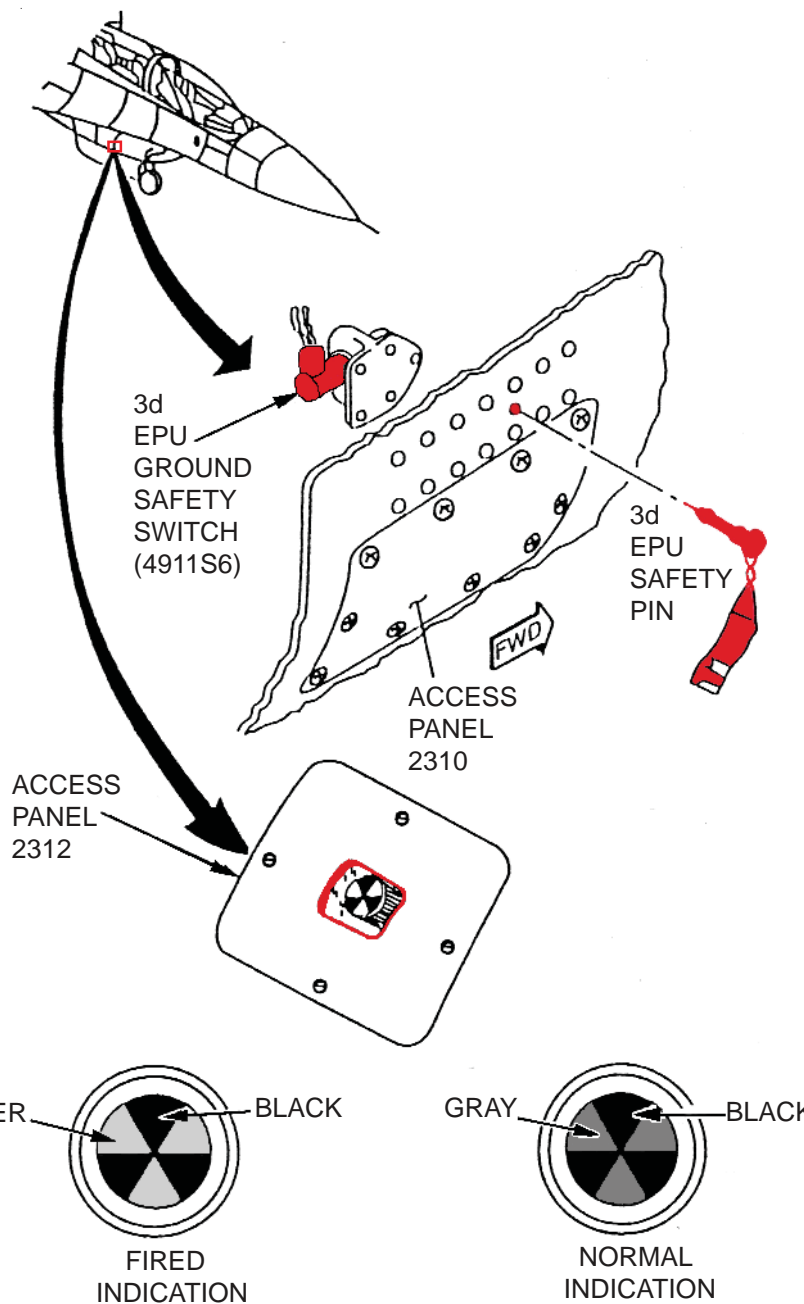

SAFETYING EJECTION SEAT

WARNING

The seat is armed regardless of canopy position. Jettisoning the aircraft canopy prepares the ACES II ejection seat for ejection. Seat(s) can eject whether canopy is opened or closed. On two seat aircraft, both seats must be safetied before either can be considered safe. Extreme caution must be used not to inadvertently move the Ground Safety Lever from the SAFE position during aircrew extraction. DO NOT USE PITOTS FOR HANDHOLD DURING ANY TIME OF THE OPERATION.

1. NORMAL SAFETYING EJECTION SEAT

NOTE:

The Ground Safety Lever Safety Pin can be installed regardless of seat position.

- a. Rotate Ground Safety Lever, located on left side of seat, UP and FORWARD, and install safety pin in pin receptacle at base of lever near pivot point. Pin faces forward. If safety pin can not be installed, tape or tie Ground Safety Lever in UP position to prevent arming during extraction.
- b. Install Safety Pin in the Emergency Manual Chute Handle. If Ground Safety Pin and Emergency Manual Chute Handle Pin are connected by one safety streamer, route Emergency Manual Chute Handle safety pin under aircrew's legs, otherwise extraction will cause entanglement with streamer.

2. EMERGENCY SAFETYING EJECTION SEAT

- a. Rotate Ground Safety Lever, located on left side of seat, UP and FORWARD.
- b. Insure Ground Safety Lever does not rotate downward and arm seat during extraction or movement of aircrew.

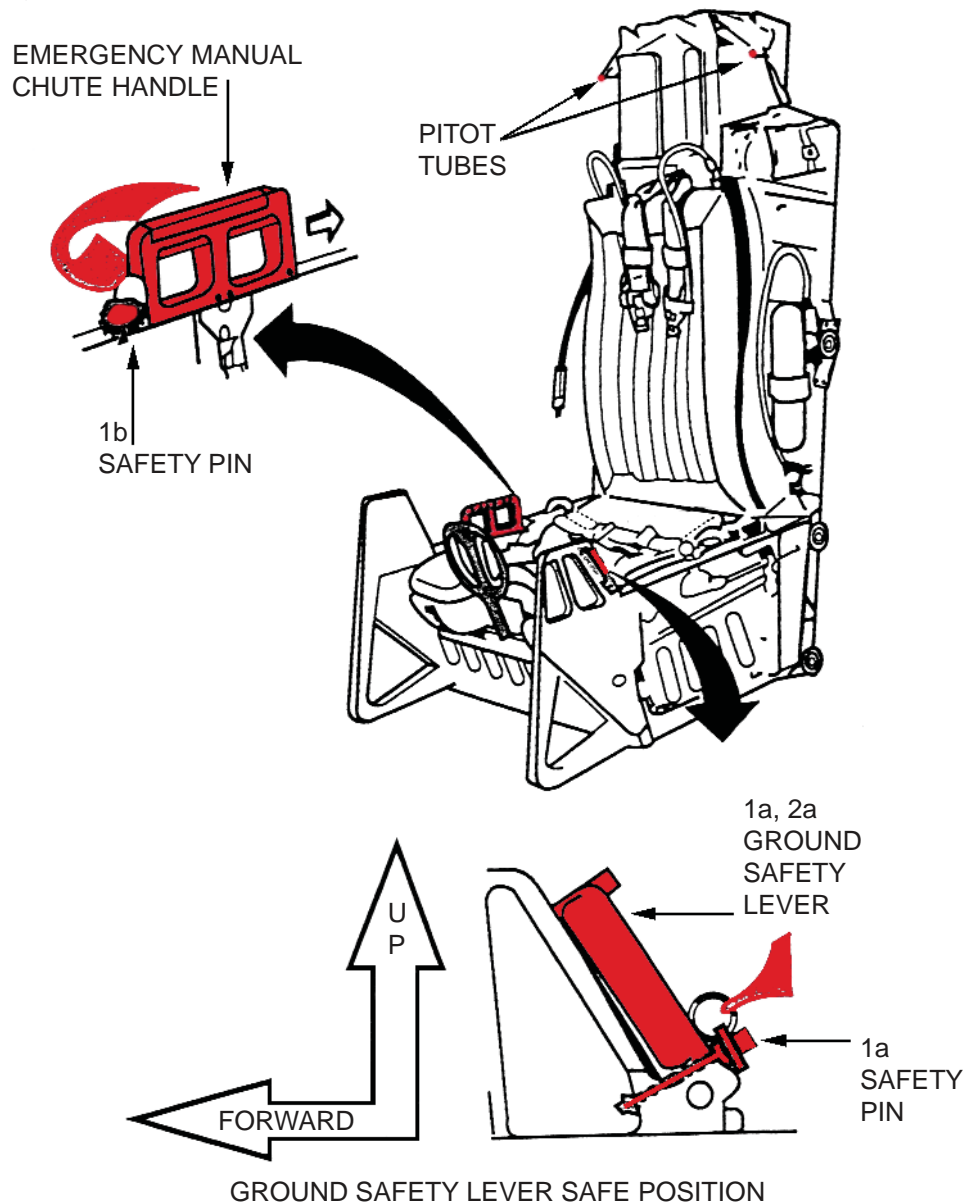

AIRCREW EXTRACTION

F-16

3. AIRCREW EXTRACTION

NOTE:

Use of Emergency Manual Chute Handle **DOES NOT** release aircrew restraints.

- Release lap belt by squeezing latch and release bar simultaneously.
- Release left and right survival kit buckles by depressing PUSH TO RELEASE button on each buckle.
- Release left and right shoulder harness fittings by squeezing latch and release bar simultaneously for each fitting. (See pg F-16.27 for additional information.)

NOTE:

- If the aircraft has collapsed landing gear or is in a gear up configuration and if time permits after rescue is complete, disconnect the electrical harness from the Flight Data Recorder, located on the left upper portion of the seat (front seat only on F-16B aircraft.) Grasp the lanyards attached to the connector and pull sharply downward. This will preserve recorded data of the mishap.
- The "G" suit hose located to the left side of the seat is directional in its separation at the disconnect. Pull straight down with a 12 to 70 pound pull force. If an offset direction is taken to disconnect hose from aircrew member, disconnect will not occur.

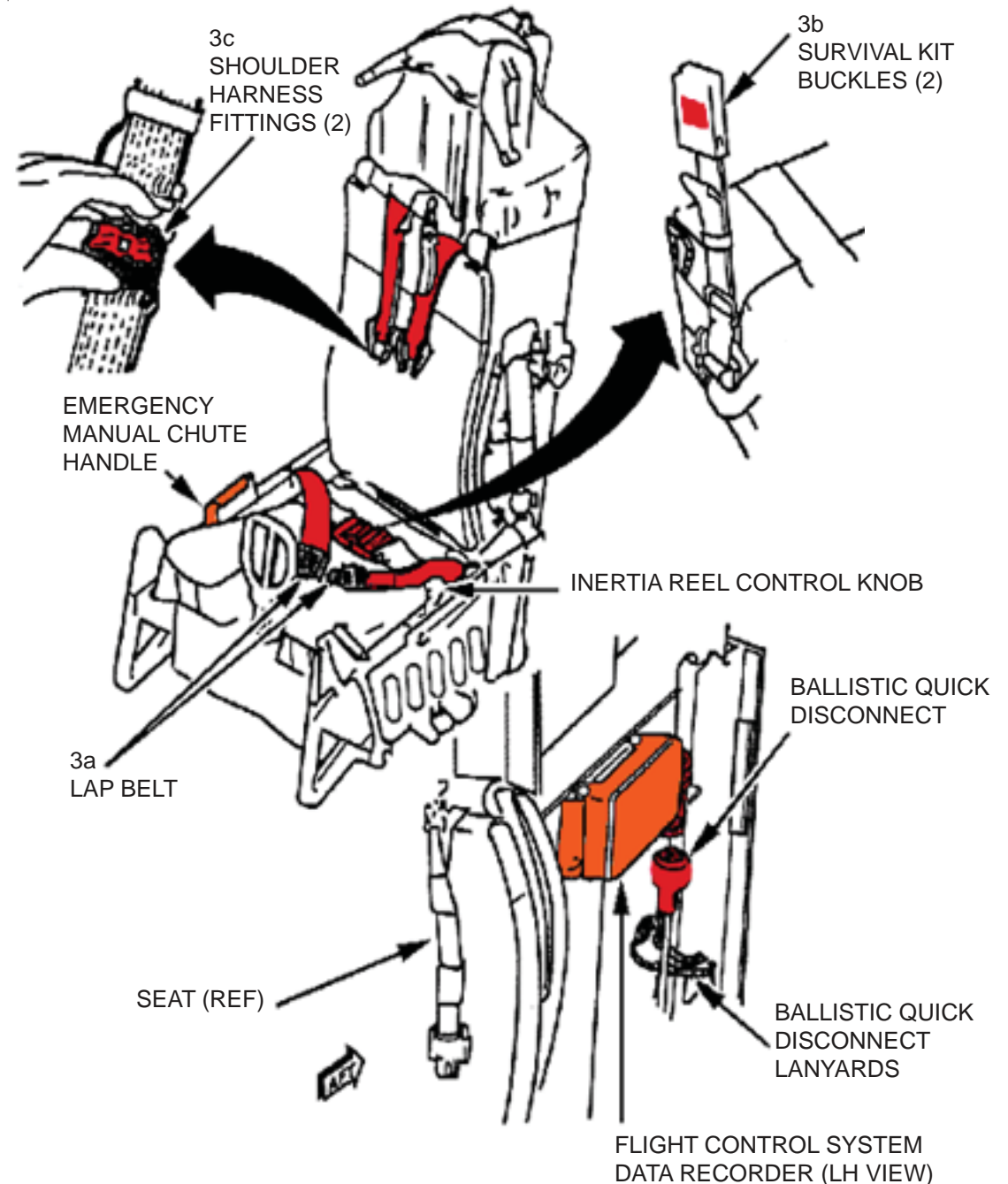

AIRCREW EXTRACTION-Continued

3. AIRCREW EXTRACTION - Continued

NOTE:

The shoulder harness fittings encountered may be different than the fitting mentioned on page F-16.22. Fittings may be a First or Second generation Koch or a Frost.

- d. Release left and right Frost shoulder harness fittings by squeezing latch and release bar simultaneously for each fitting.
- e. Release left and right First Generation Koch shoulder harness fittings by rotating and holding safety cover downward, then pushing thumb catch upward to release straps.
- f. Release left and right Second Generation Koch shoulder harness fittings by lifting the safety cover, access the release bar, then rotate release bar downward to release straps.
- g. The chest and leg strap ejector snap is released by pulling on the thumb release.

3d
SQUEEZE LATCH

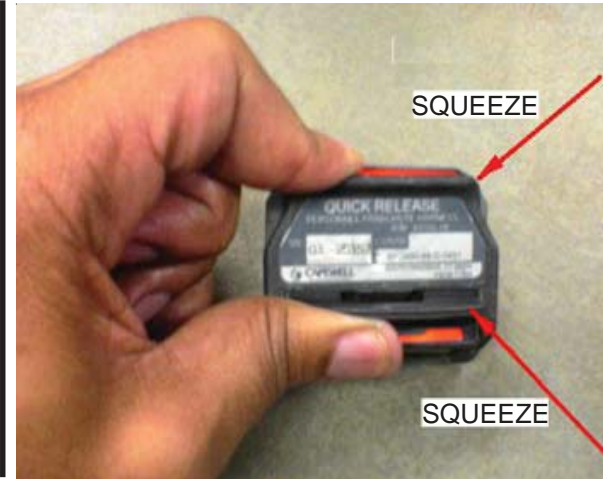

3d
SHOULDER HARNESS FITTINGS (2)
(FROST PARACHUTE CANOPY
RELEASE BODY, PN 81116-10)

3e
THUMB CATCH

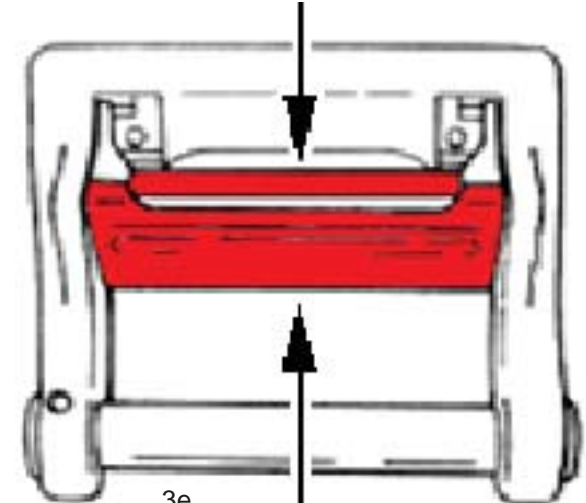

3e
SAFETY COVER

3e
SHOULDER HARNESS FITTINGS (2)
(1st GENERATION KOCH PARACHUTE
CANOPY RELEASE BODY, PN 015-11038-1)

3f
SAFETY COVER

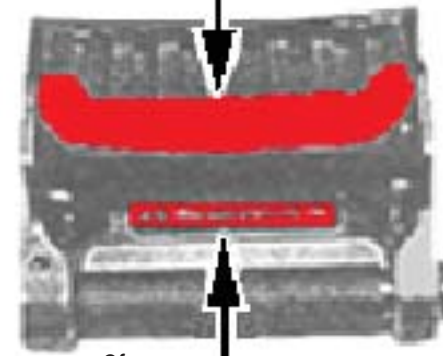

3f
RELEASE BAR

3f
SHOULDER HARNESS FITTINGS (2)
(2nd GENERATION KOCH PARACHUTE
CANOPY RELEASE BODY, PN 990010-1)

SQUEEZE
AND PULL
ON THUMB
GUARD



3g
CHEST AND LEG STRAP EJECTOR
SNAP WITH CATCH (PN 68D37721)